

MULTIUSO Multiuso Multiuse 	7020/6020-50 - Branco/Blanco/White
	7020/6020-96 - Freijo/Baunilha Freijo/Vainilla - Freijo/Vanilla
	7020/6020-97 - Freijo/Freijo/Freijo
	7020/6020-98 - Freijo/Carbono Freijo/Carbono - Freijo/Carbon

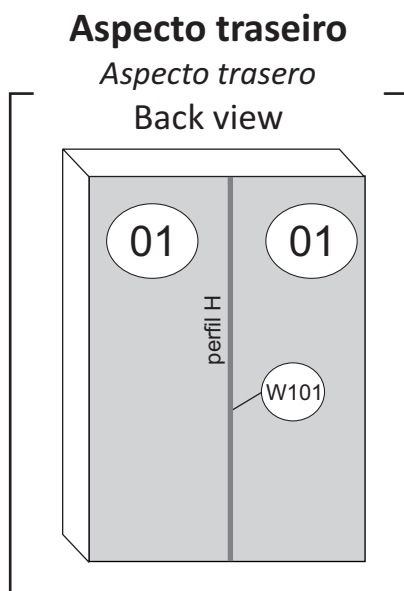
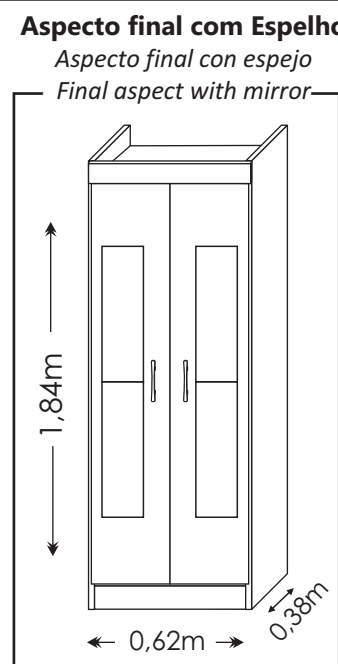
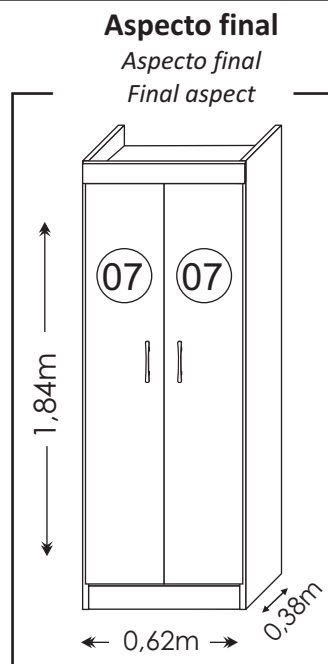
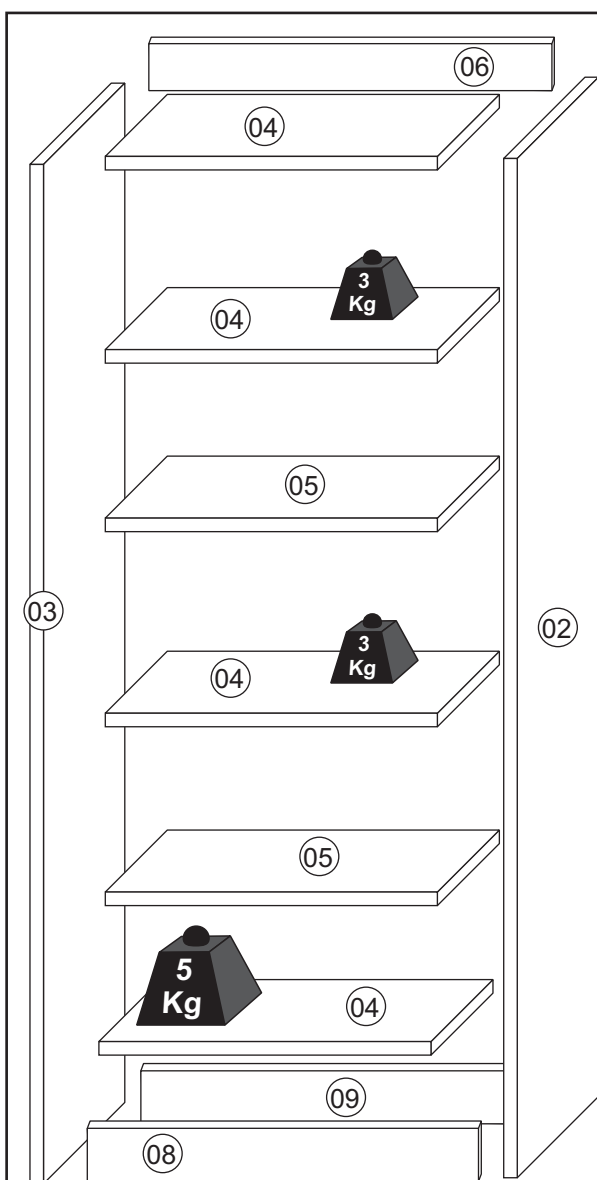

ATENÇÃO/ATENCIÓN/ATTENTION

Ao realizar solicitações de Assistência Técnica, favor seguir as orientações abaixo:
 1º - Informar o MODELO do Roupeiro (Ex.: 6020-50) / 2º - Informar o CÓDIGO da Peça (Ex.: 196) / 3º - Informar o CÓDIGO do Revest. (Ex.: 100) / As solicitações de peças deverão ser encaminhado via email: assistencia@araplac.com.br

Quando solicite Asistencia Técnica, por favor siga las orientaciones abajo:
 1º - Informe el MODELO del Ropero (Ej.: 6020-50) / 2º - Informe el CÓDIGO de la Pieza (Ej.: 196) / 3º - Informe el CÓDIGO del revestimiento de la Pieza (Ej.:100) / Las solicitudes de piezas deberán ser dirigidas vía email: assistencia@araplac.com.br

When Technical Assistance is required, please follow the instructions below:
 1º - Inform the MODEL (Ex.:6020-50) / 2º - Inform THE PIECE CODE (Ex.:196) / 3º - Inform THE FINISHING PIECE CODE (Ex: 100). Pieces must be required at assistencia@araplac.com.br

Lista de Peças / Lista de Piezas / List of Pieces

Peça Piezas Piece	Descrição / descripción / description	Medida (mm) Medida (mm) Size (mm)	Qtde. Cant Quantity.	Código da PEÇA Código de la pieza Piece code	Branco	Freijó/Baunilha	Freijó	Freijó/Carbono	Mat. Prima Mat. Prima Raw material
					Blanco	Freijo/Vainilla	Freijo	Freijo/Carbono	
					CÓD.DO REV. DA PEÇA Código de revestimiento de la pieza Piece finishing code				
01	Fundo / Fondo / Back panel	302 X 1715 X 03	02	196	100	1988	1988	1988	DURATREE
02	Lateral dir. / Lateral derecho/ Right side panel	360 X 1840 X 12	01	1264	100	198	198	198	MDP
03	Lateral esq./ Lateral izquierdo / Left side panel	360 X 1840 X 12	01	1265	100	198	198	198	MDP
04	Prateleira (1 lado) FIXA / Repisa Fija / Fixed shelf	360 X 590 X 12	04	2324	100	1988	1988	1988	MDP
05	Prateleira (1 lado) MÓVEL /Repisa móvil/ Mobile shelf	360 X 590 X 12	02	2325	100	1988	1988	1988	MDP
06	Moldura / Moldura / Frame	615 X 60 X 15	01	1335	100	198	198	198	MDP
07	Porta / Puerta / Door	299 X 1708 X 15	02	1477	100	119889	198	298	MDP
08	Rodapé frontal / Rodapié frontal / Frontal baseboard	590 X 60 X 15	01	2574	100	198	198	198	MDP
09	Rodapé traseiro / Rodapié posterior / Back baseboard	590 X 60 X 15	02	2575	99	99	99	99	MDP

KIT DE ACESSÓRIOS / Kit de Accesorios/ Kit of accessories

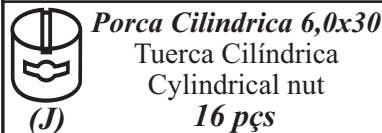

Porca Cilindrica 6,0x30
Tuerca Cilindrica
Cylindrical nut
(J) 16 pçs



Parafuso 3,5x12
Tornillo 3,5x12
Screw 3,5x12
(II) 34 pçs



Preço 10x10
Clavo 10x10
Nail 10x10
(K) 40 Pçs

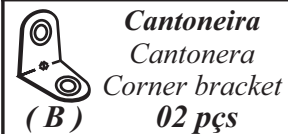

Cantoneira
Cantoneira
Corner bracket
(B) 02 pçs

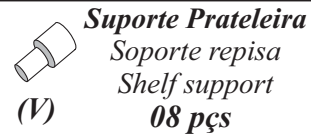

Suporte Prateleira
Soporte repisa
Shelf support
(V) 08 pçs

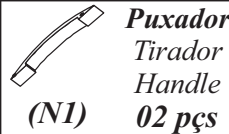

Puxador
Tirador
Handle
(NI) 02 pçs

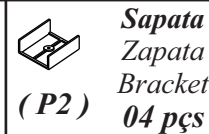

Sapata
Zapata
Bracket
(P2) 04 pçs



Dobradiça
Bisagra
Metal Hinge
(G) 06 pçs

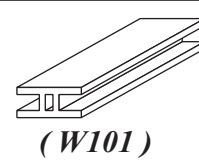

Perfil Plástico H 1715mm
Perfil plastico 1715mm
Plastic Profile 1715mm
(W101) 01 pçs

3 *FIXAR A PRATELEIRA MÓVEL NAS LATERAIS.
Fijar la repisa móvil en los laterales con el soporte repisa
Put the mobile shelf to the side panels with shelf support.

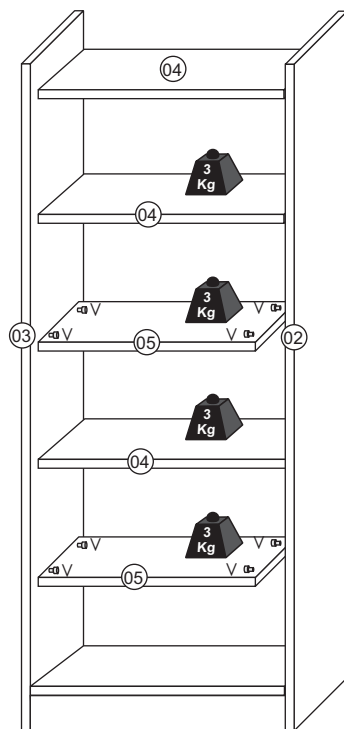

4 *FIXAR A MOLDURA.
Fijar la moldura
Screw the frame

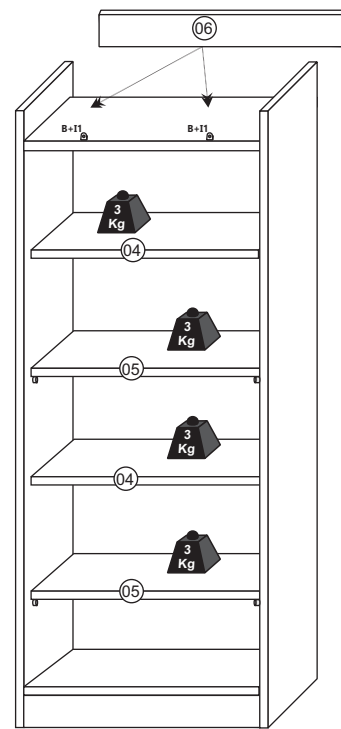

1 *FIXAR OS RODAPÉS FRONTAL E TRASEIRO NAS LATERAIS
Fijar los rodapiés frontal y posterior en las laterales
Screw the frontal and back baseboard to the side panels

***FIXAR A PRATELEIRA (1 FACE) NAS LATERAIS.**
Fija la repisa fija (1 face) en las laterales
Screw the fixed shelf to the side panels.

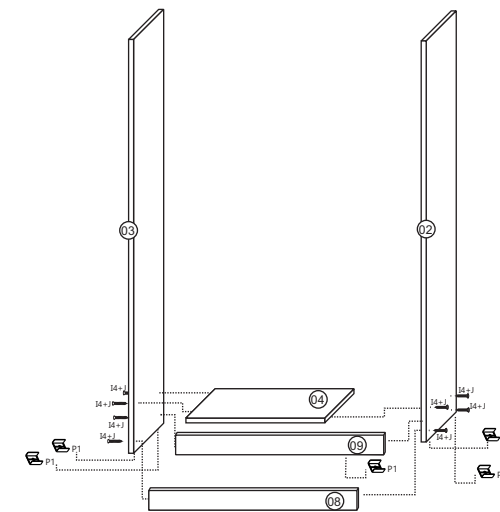

2 *FIXAR A PRATELEIRA (1 FACE) NAS LATERAIS
Fijar la repisa (1 face) en las laterales
Screw the fixed shelf to the side panels.

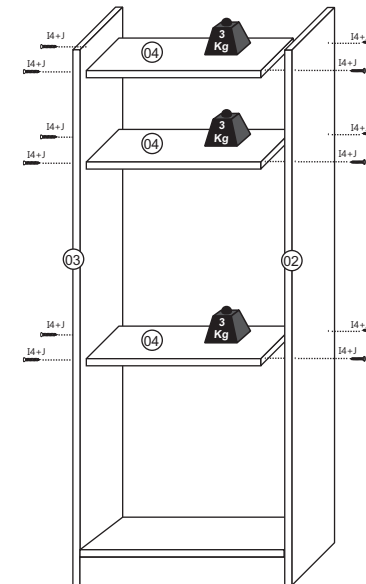

5 *FIXAR AS PORTAS UTILIZANDO DOBRADIÇA
Fijar las puertas utilizando la bisagra
Screw the door with the hinge

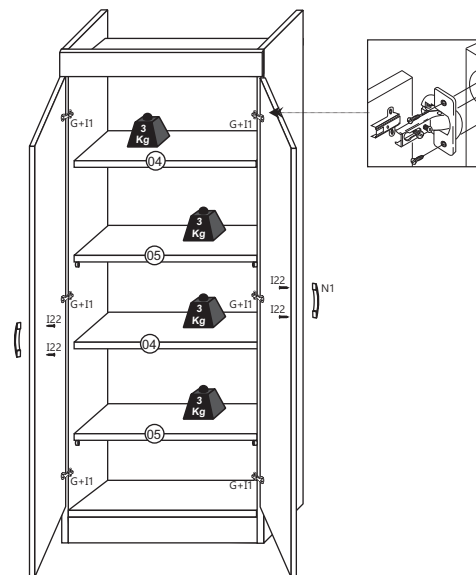

6 *FIXAR OS FUNDOS
Fijar los fondos
Set the back panel

