

GUARDA-ROUPA

10 portas - 3 gavetas
Corrediça Metálica

18490-50 Branco
18490-77 Imbuia
18490-78 Imbuia/Avela
18490-88 Demolição
18490-89 Demolição/Baunilha

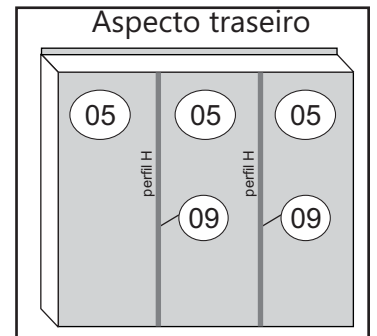
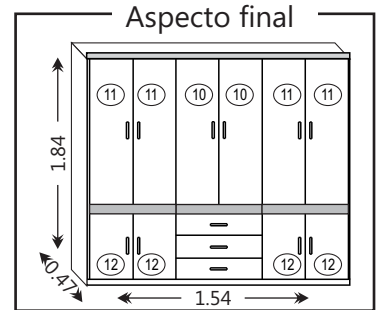
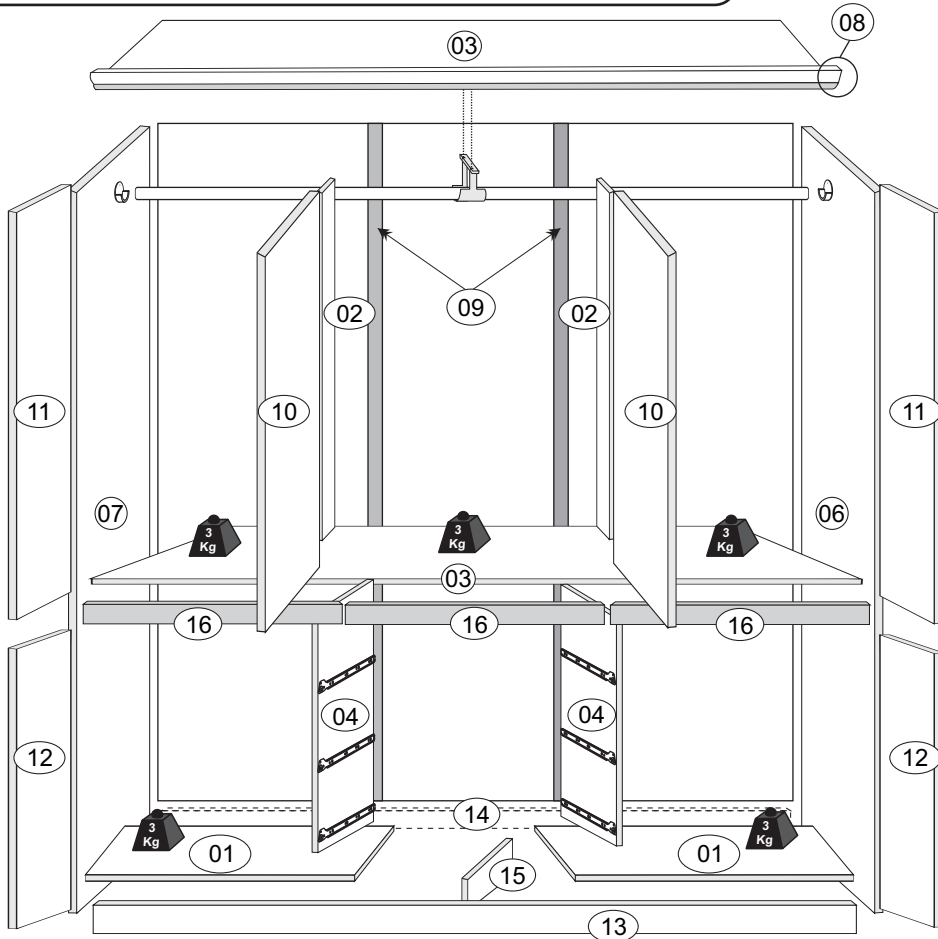
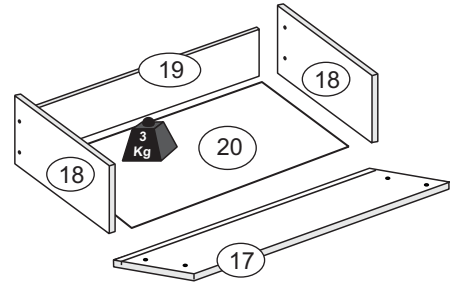

ATENÇÃO

Ao realizar solicitações de Assistência Técnica, favor seguir as orientações abaixo:

- 1º - Informar o MODELO do Roupeiro (Ex.: 18490-50)
- 2º - Informar o CÓDIGO da Peça (Ex.: 23)
- 3º - Informar o CÓDIGO do revestimento da Peça (Ex.: 100)

As solicitações de peças deverão ser encaminhado via email: assistencia@araplac.com.br

Legenda de Peças

Peça	Descrição	Medida (mm)	Qtde.	Código da PEÇA p/ Assistência Técnica	Branco	Imbuia	Imbuia/Avela	Demolição	Dem/Baunilha	Mat. Prima
					CÓDIGO DO REVESTIMENTO DA PEÇA					
01	Base rodapé	525x450x12	02	9010	100	1777	1777	1888	1888	MDP
02	Batente	1123x90x12	02	51	100	1777	1777	1888	1888	MDP
03	Base Prateleira / Chapéu	1515x450x12	02	101	100	1777	1777	1888	1888	MDP
04	Divisória	532x450x12	02	9009	100	1777	1777	1888	1888	MDP
05	Fundo	500x1695x2,5	03	193	100	1777	1777	1888	1888	DURATREE
06	Lateral dir.	1840x450x12	01	234	100	177	177	188	188	MDP
07	Lateral esq.	1840x450x12	01	260	100	177	177	188	188	MDP
08	Moldura	1540x53x15	01	298	100	177	177	188	188	MDP
09	Coluna	1670x40x15	02	404	100	1777	1777	1888	1888	MDP
10	Porta central	1142x251x15	02	464	117	177	177	188	1891	MDP
11	Porta maior lateral	1142x251x15	04	521	117	177	16441	188	1891	MDP
12	Porta menor lateral	476x251x15	04	489	117	177	16441	188	1891	MDP
13	Rodapé frontal	1515x100x15	01	566	100	177	177	188	188	MDP
14	Rodapé traseiro	1515x100x15	01	575	99	99	99	99	99	MDP
15	Trava do rodapé	419x100x15	01	580	99	99	99	99	99	MDP
16	Vista frontal	497x70x12	03	614	100	177	177	188	188	MDP
17	Frente da gav.	504x157x15	03	698	117	177	177	188	1891	MDP
18	Lateral da gav.	370x100x12	06	704	100	1777	1777	1888	1888	MDP
19	Contra fundo da gav.	448x80x12	03	729	100	1777	1777	1888	1888	MDP
20	Fundo da gav.	380x470x2,5	03	758	100	1777	1777	1888	1888	DURATREE

Kit de Acessórios



Cavilha 6x30 - 28 Pçs

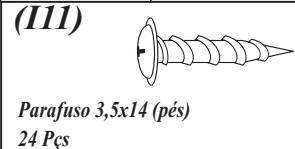
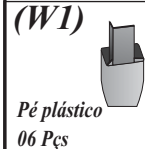
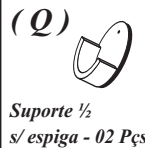
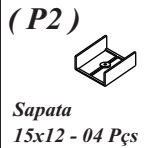
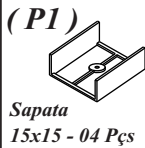
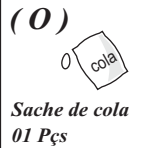
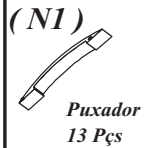
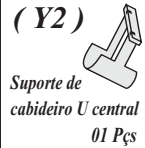
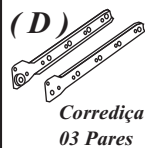
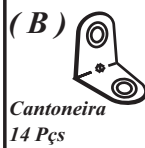
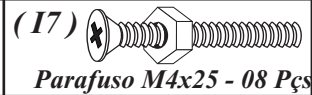
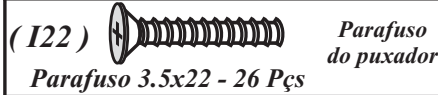
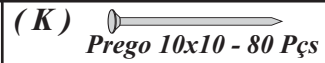

5

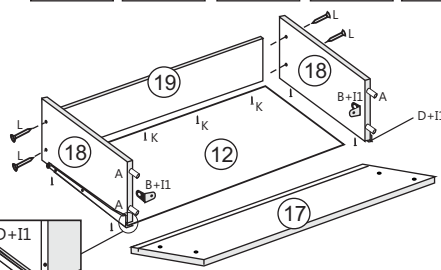
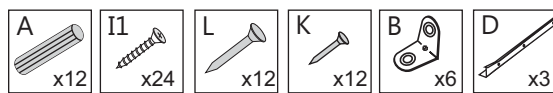

correia metálica

- 1º Encaixe as laterais na frente da gaveta com cavilhas, cantoneiras metálicas e cola.
- 2º Encaixar o fundo da gaveta e contra-fundo da gaveta.
- 3º Pregar as laterais no contra-fundo com prego 13x15.
- 4º Pregar o fundo da gaveta no contra-fundo por baixo com prego 10x10 e os parafusos da correia metálica servirão também para parafusar os fundos da gaveta nas laterais.

1

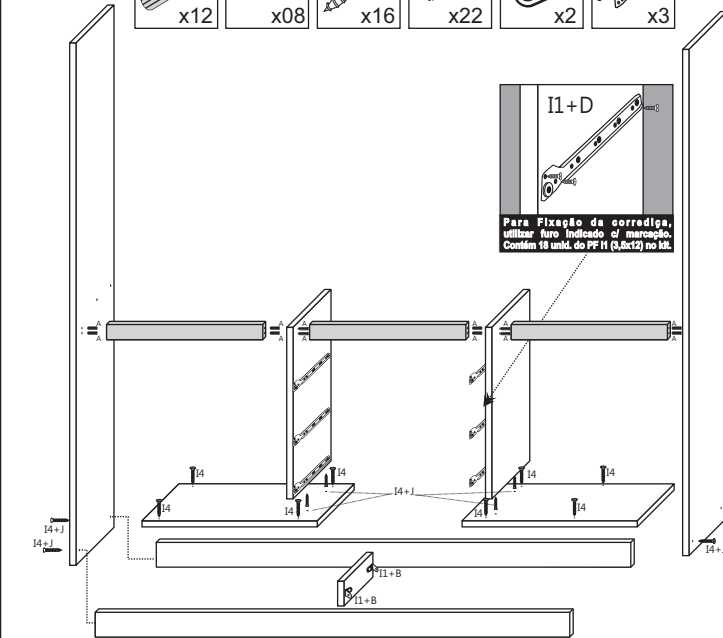
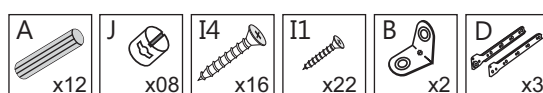

Para Fixação da correia, utilizar furo indicado cf. marcação. Contém 19 unidades do PF11 (2,8x12) no kit.

2

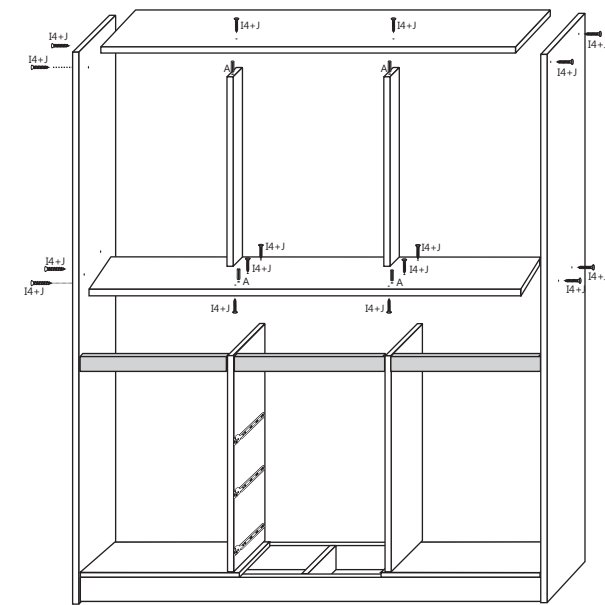
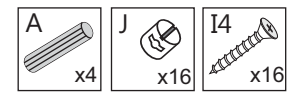

3

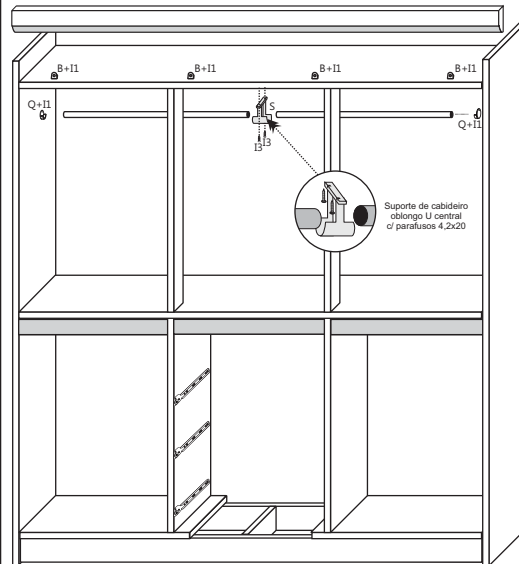
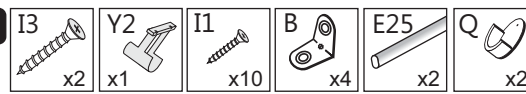

Suporte de cabideiro cobinço U central cf. parafusos 4,2x20

4

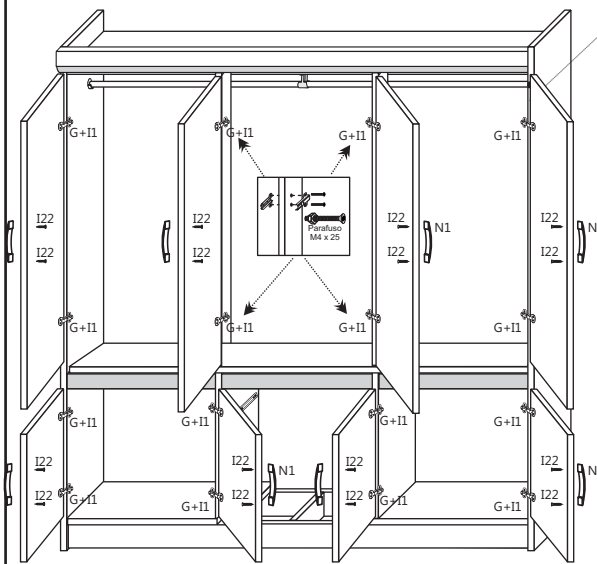
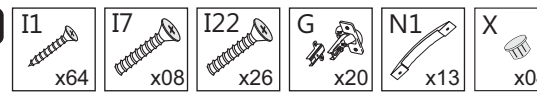

5

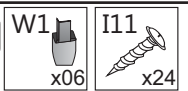

Obs.: Os parafusos utilizados para a fixação dos pés plásticos encontram-se em um sub-kit dentro do kit de acessórios principal.

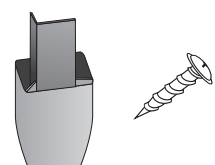

A montagem dos pés é opcional, e para tal basta posicioná-los, após o passo 01, internamente entre as laterais e rodapés, e parafusá-los de dentro para fora.