

GUARDA-ROUPA
2 portas - 2 gavetas
Corrediça Metálica

20022-56 Branco/Lilás
20022-79 Imbuia/Baunilha
20022-89 Demolição/Baunilha

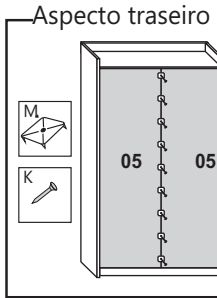

Kit de Acessórios (I4)

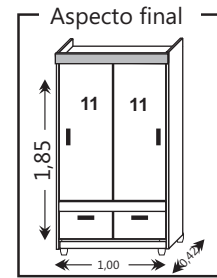
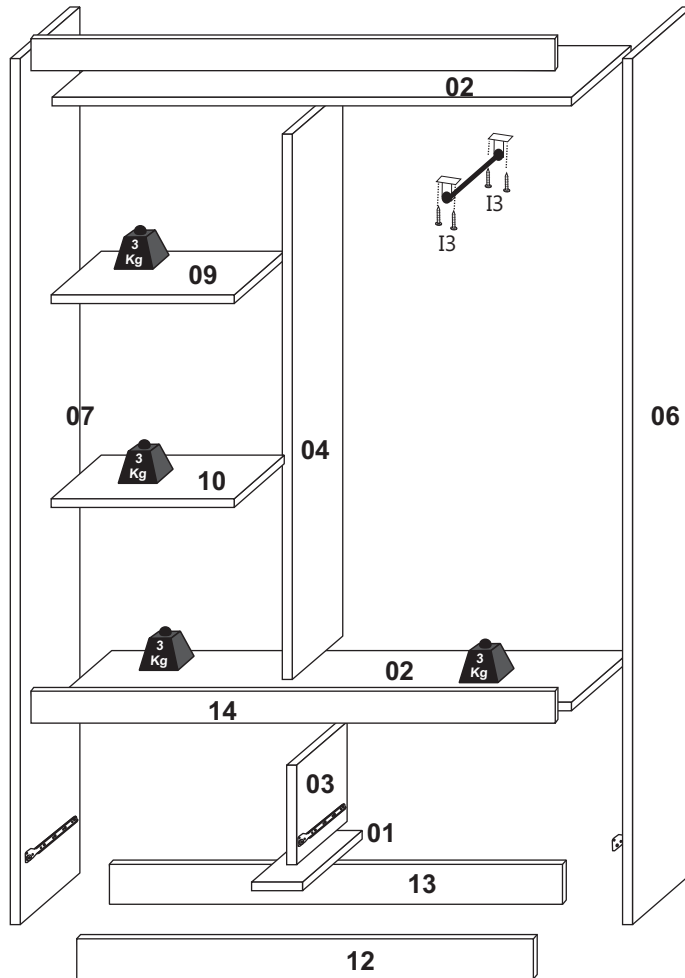
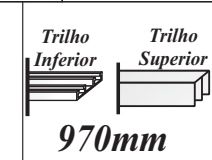
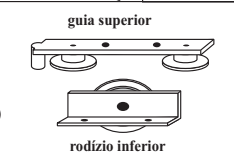
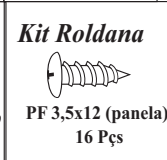
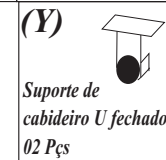
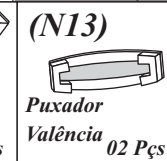
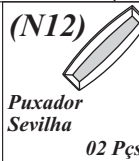
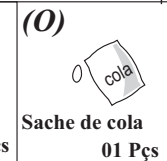
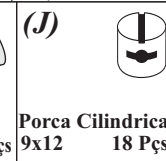
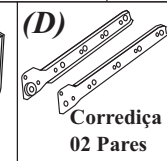
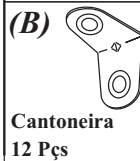
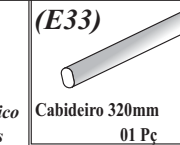
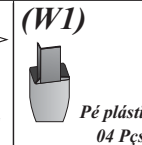
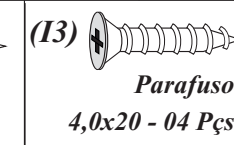
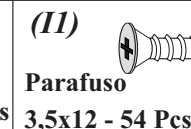
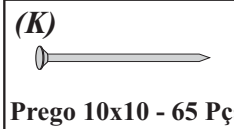
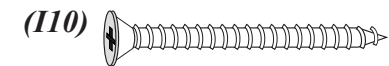
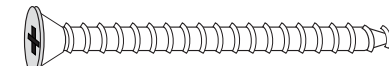
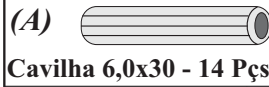

ATENÇÃO

Ao realizar solicitações de Assistência Técnica, favor seguir as orientações abaixo:
1º - Informar o MODELO do Roupeiro (Ex.: 20022-56)
2º - Informar o CÓDIGO da Peça (Ex.: 10018)
3º - Informar o CÓDIGO do revestimento da Peça (Ex.: 100)

As solicitações de peças deverão ser encaminhado via email: assistencia@araplac.com.br

Legenda de Peças

Peça	Descrição	Medida (mm)	Qtde.	Código da PEÇA p/ Assistência Técnica	CÓDIGO DO REVESTIMENTO DA PEÇA			Mat. Prima
					Bco/Rosa	Imbuia/Baun	Dem/Baunilha	
01	Base Rodapé	400x80x12	01	10018	100	1777	1888	MDP
02	Base Prateleira / Chapéu	980x400x12	02	10017	100	1777	1888	MDP
03	Divisória	305x400x12	01	10016	100	1777	1888	MDP
04	Divisória	1282x335x12	01	10015	100	1777	1888	MDP
05	Fundo	498x1630x2,5	02	10037	100	1777	1888	DURATREE
06	Lateral Direita	1780x400x12	01	10013	100	177	188	MDP
07	Lateral Esquerda	1780x400x12	01	10014	100	177	188	MDP
08	Moldura	1004x100x15	01	10031	1156	177	188	MDP
09	Prateleira (2 lados) fixa	484x335x12	01	10022	100	1777	1888	MDP
10	Prateleira (1 lado) móvel	484x335x12	01	10028	100	1777	1888	MDP
11	Porta	1253x510x12	02	10027	117	1791	1891	MDP
12	Rodapé Frontal	980x100x15	01	10019	116	177	188	MDP
13	Rodapé Traseiro	980x100x15	01	10020	100	99	99	MDP
14	Vista Frontal	1004x100x15	01	10021	100	99	99	MDP
15	Frente da Gaveta	493x237x15	02	10024	100	177	188	MDP
16	Lateral da Gaveta	370x140x12	04	703	100	1777	1888	MDP
17	Contra Fundo da Gaveta	436x140x12	02	10025	100	1777	1888	MDP
18	Fundo da Gaveta	380x458x2,5	02	10103	100	1777	1888	DURATREE

Régua para Medição de Parafusos

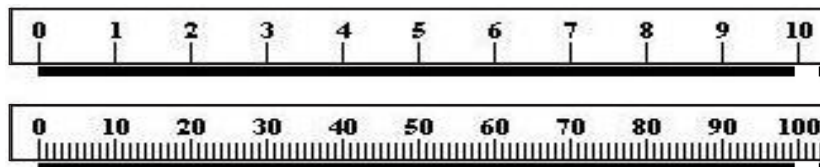

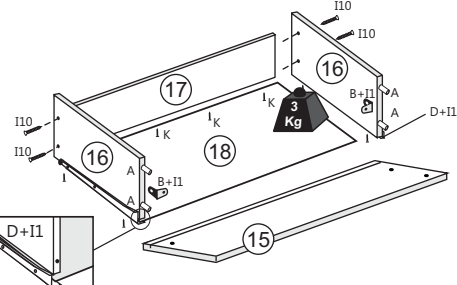
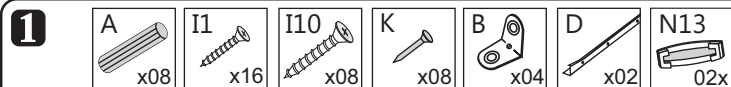

corrediça metálica

- 1º Encaixe as laterais na frente da gaveta com cavilhas, cantoneiras metálicas e cola.
- 2º Encaixar o fundo da gaveta e contra-fundo da gaveta.
- 3º Parafusar as laterais no contra-fundo com parafuso 3,5x35.
- 4º Pregar o fundo da gaveta no contra-fundo por baixo com prego 10x10 e os parafusos da corrediça metálica servirão também para parafusar os fundos da gaveta nas laterais.

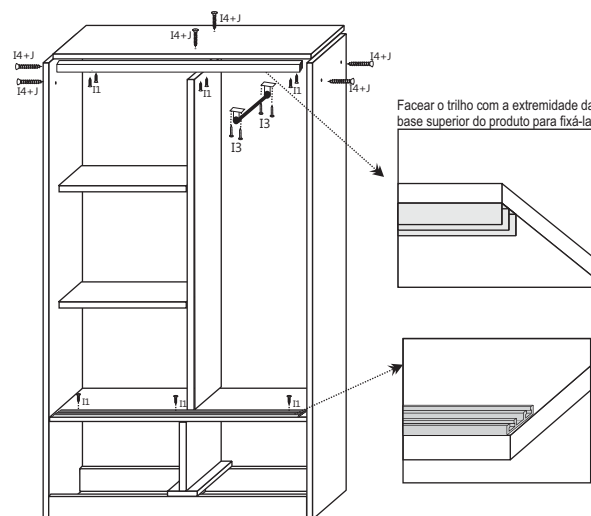
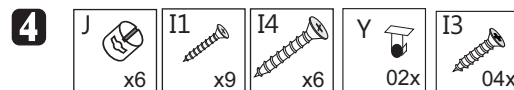
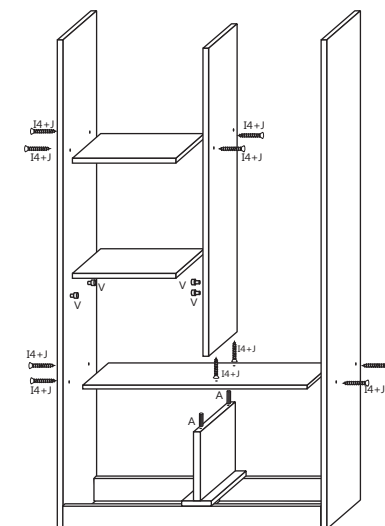
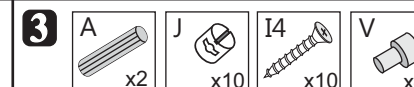
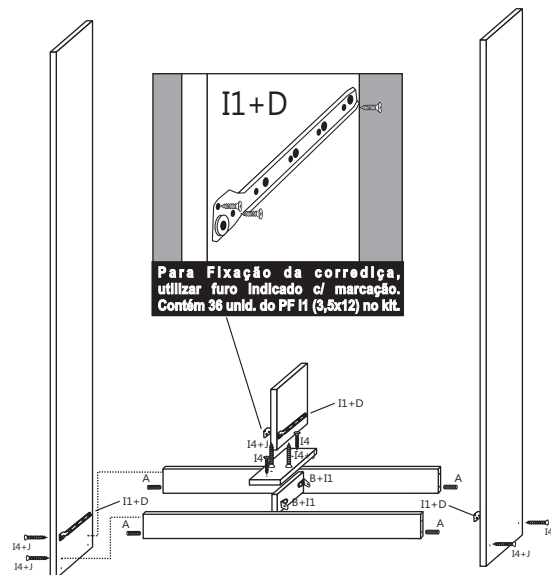

*** Posicionar as portas antes de fixar as vistas frontais.**

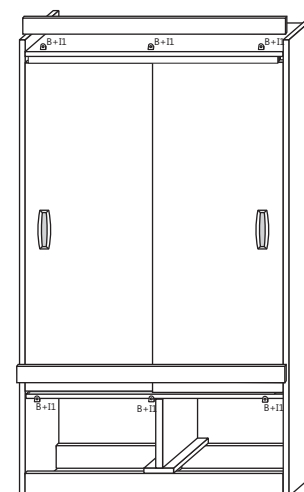
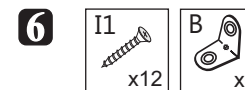
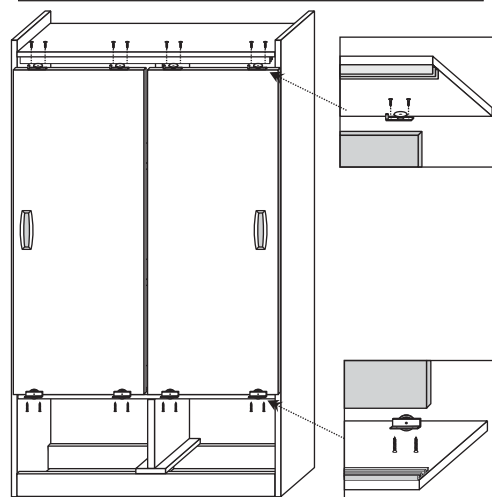

7 Montagem dos Pés

A montagem dos pés é opcional, e para tal basta posicioná-los, após o passo 02, entre as laterais e rodapés e parafusá-los de dentro para fora.

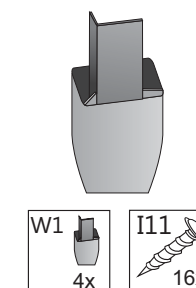

Obs.: Os parafusos utilizados para a fixação dos pés plásticos encontram-se em um sub-kit dentro do kit de acessórios principal.